

OLYMPUS®

Quick Start Guide SP-320 Start Here

For more information, please refer to the Basic & Advanced Manuals or visit: www.olympusamerica.com/support

OLYMPUS IMAGING AMERICA INC.

BEFORE YOU BEGIN

Gather these items (box contents)

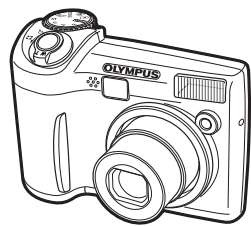

Digital Camera

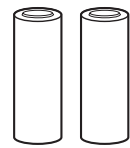

Two AA batteries

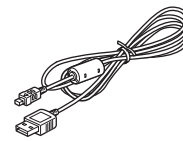

USB Cable

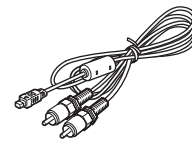

AV Cable



OLYMPUS Master Software CD-ROM

Items not shown: Strap, Advanced Manual (CD-ROM), Basic Manual, warranty card. Contents may vary depending on purchase location.

1 GET STARTED

a. Attach the strap

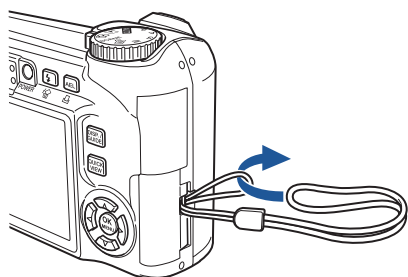

b. Insert the battery

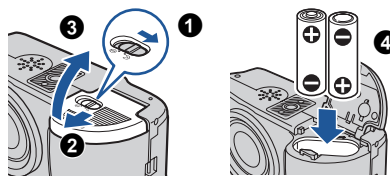

c. Set the date and time

- Set the mode dial to **AUTO**, and press the **POWER** button to turn the camera on.
- Press **[MENU]** to display the top menu, and select [MODE MENU] > [SETUP] > [DATE/TIME].
- Press **[LEFT]**/**[RIGHT]** to set an item. Press **[LEFT]**/**[RIGHT]** to select the next field.

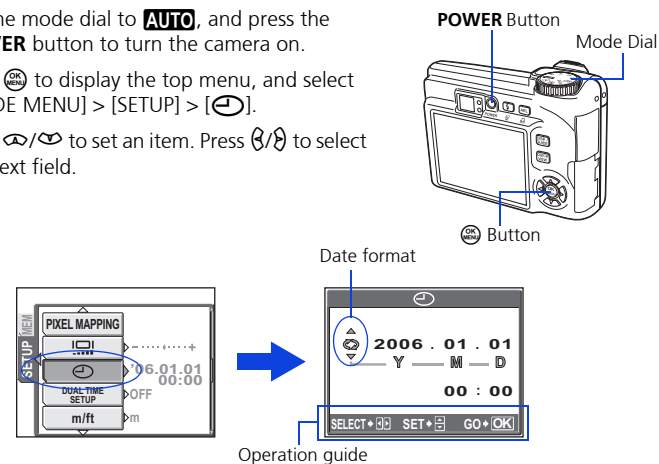

2 TAKE A PICTURE

a. Zoom

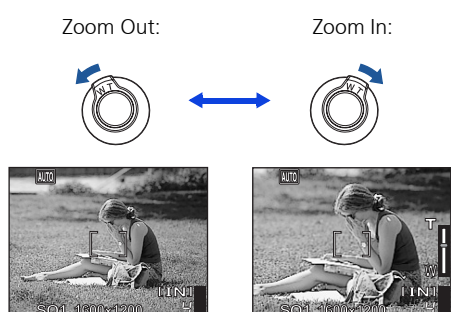

b. Focus

- Using the monitor, place the AF target mark over your subject.

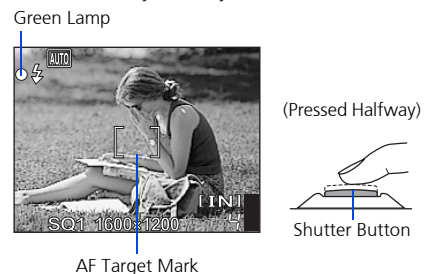

- Press and hold the shutter button halfway to lock the focus.
 - The green lamp indicates the focus and exposure are locked.

c. Take the picture

- Press the shutter button completely to take the picture.

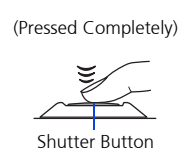

CAMERA DIAGRAM

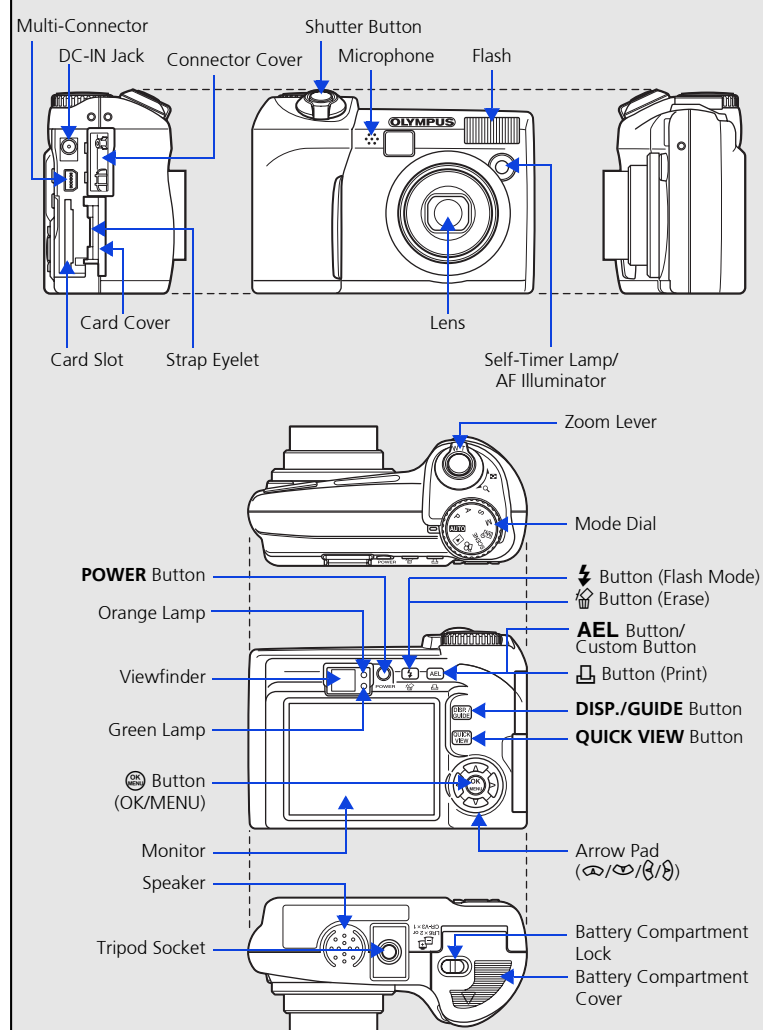

3 REVIEW OR ERASE A PICTURE

a. Press the QUICK VIEW button

- The last picture taken will be displayed.

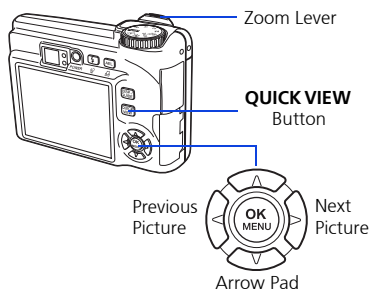

b. Take a closer look

- Pull the zoom lever toward T or W to zoom in or out.
- Press **[MENU]** to return to the original size.
- Press the arrow pad (**[LEFT]**/**[RIGHT]**) to scroll around.

Press the **QUICK VIEW** button again to return to shooting mode.

c. To erase a picture

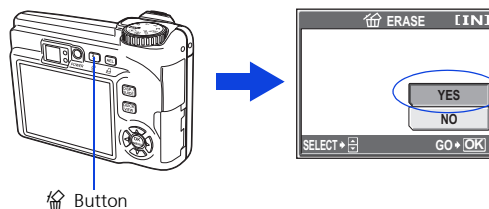

- Display the picture you want to erase.
- Press the **[MENU]** button.
- Select [YES], and press **[MENU]**.
 - The picture is permanently erased.

4 TRANSFER IMAGES

a. Install the software

- Insert the OLYMPUS Master CD-ROM.
- Windows:** Click the "OLYMPUS Master" button.
Macintosh: Double-click the "Installer" icon.
- Simply follow the on-screen instructions.
 - Remember to register your camera when you install OLYMPUS Master or visit: www.olympusamerica.com/prodreg

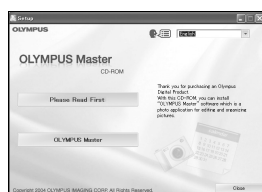

b. Connect the camera to the computer

- Connect the camera and computer using the USB cable (included).
 - The monitor will turn on automatically.

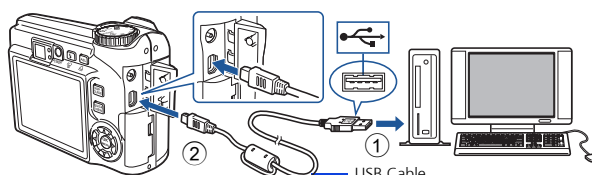

- Select [PC] on the monitor, and press **[MENU]**.

- Your PC will now recognize your camera as a removable storage drive.

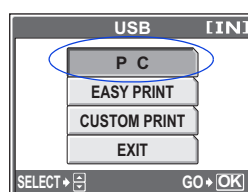

c. Transfer images to the computer

- With the camera now connected, open OLYMPUS Master.
 - The [Transfer Images] window is displayed.
- Select the images you want to transfer, and click the [Transfer Images] button.

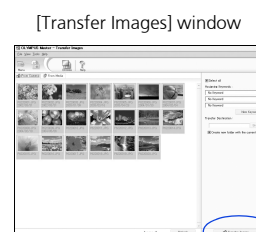

If the [Transfer Images] window is not displayed automatically:

- Click the "Transfer Images" icon on the OLYMPUS Master main menu.
- Click the "From Camera" icon.

